

N and P-Channel Enhancement Mode Power MOSFET

Description

The HM4622 uses advanced trench technology to provide excellent $R_{DS(ON)}$ and low gate charge . This device is suitable for use as a load switch or in PWM applications.

General Features

● **N-Channel**

$V_{DS} = 20V, I_D = 5.0A$

$R_{DS(ON)} < 33m\Omega @ V_{GS}=4.5V$

$R_{DS(ON)} < 40m\Omega @ V_{GS}=2.2V$

● **P-Channel**

$V_{DS} = -20V, I_D = -5.0A$

$R_{DS(ON)} < 52m\Omega @ V_{GS}=-4.5V$

$R_{DS(ON)} < 75m\Omega @ V_{GS}=-2.5V$

- High power and current handing capability
- Lead free product is acquired
- Surface mount pack age

Application

- PWM applications
- Load switch
- Power management

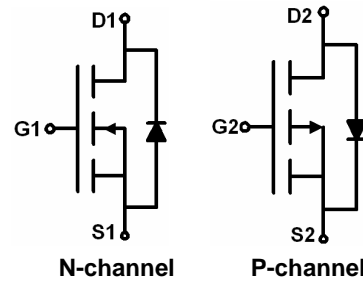

Schematic diagram

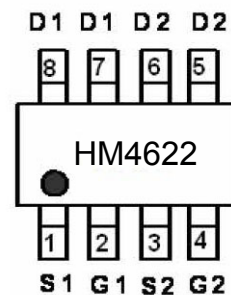

Marking and pin assignment

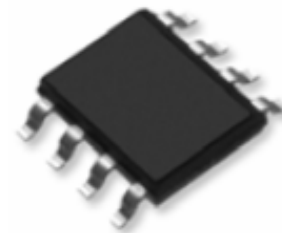

SOP-8 top view

Package Marking and Ordering Information

Device Marking	Device	Device Package	Reel Size	Tape width	Quantity
HM4622	HM4622	SOP-8	Ø330mm	12mm	2500 units

Absolute Maximum Ratings ($T_A=25^\circ C$ unless otherwise noted)

Parameter	Symbol	N-Channel	P-Channel	Unit
Drain-Source Voltage	V_{DS}	20	-20	V
Gate-Source Voltage	V_{GS}	±12	±12	V
Continuous Drain Current	I_D	5.0	-5.0	A
Pulsed Drain Current (Note 1)	I_{DM}	20	-20	A
Maximum Power Dissipation	P_D	2.5	2.5	W
Operating Junction and Storage Temperature Range	T_J, T_{STG}	-55 To 150	-55 To 150	°C

Thermal Characteristic

Thermal Resistance, Junction-to-Ambient (Note2)	$R_{\theta JA}$	N-Ch	89	°C/W
		P-Ch	90	

N-CH Electrical Characteristics ($T_A=25^\circ\text{C}$ unless otherwise noted)

Parameter	Symbol	Condition	Min	Typ	Max	Unit
Off Characteristics						
Drain-Source Breakdown Voltage	BV_{DSS}	$V_{GS}=0V, I_D=250\mu A$	20	22	-	V
Zero Gate Voltage Drain Current	I_{DSS}	$V_{DS}=30V, V_{GS}=0V$	-	-	1	μA
Gate-Body Leakage Current	I_{GSS}	$V_{GS}=\pm 20V, V_{DS}=0V$	-	-	± 100	nA
On Characteristics (Note 3)						
Gate Threshold Voltage	$V_{GS(th)}$	$V_{DS}=V_{GS}, I_D=250\mu A$	0.5	0.65	1.2	V
Drain-Source On-State Resistance	$R_{DS(ON)}$	$V_{GS}=4.5V, I_D=5A$	-	22	33	m Ω
		$V_{GS}=2.5V, I_D=4A$	-	33	40	m Ω
Forward Transconductance	g_{FS}	$V_{DS}=5V, I_D=5A$	-	15	-	S
Dynamic Characteristics (Note4)						
Input Capacitance	C_{iss}	$V_{DS}=15V, V_{GS}=0V,$ $F=1.0MHz$	-	255	-	PF
Output Capacitance	C_{oss}		-	45	-	PF
Reverse Transfer Capacitance	C_{rss}		-	35	-	PF
Switching Characteristics (Note 4)						
Turn-on Delay Time	$t_{d(on)}$	$V_{DD}=15V, R_L=3\Omega$ $V_{GS}=10V, R_{GEN}=3\Omega$	-	4.5	-	nS
Turn-on Rise Time	t_r		-	2.5	-	nS
Turn-Off Delay Time	$t_{d(off)}$		-	14.5	-	nS
Turn-Off Fall Time	t_f		-	3.5	-	nS
Total Gate Charge	Q_g	$V_{DS}=15V, I_D=5A,$ $V_{GS}=10V$	-	5.2	-	nC
Gate-Source Charge	Q_{gs}		-	0.85	-	nC
Gate-Drain Charge	Q_{gd}		-	1.3	-	nC
Drain-Source Diode Characteristics						
Diode Forward Voltage (Note 3)	V_{SD}	$V_{GS}=0V, I_S=5A$	-	-	1.2	V
Diode Forward Current (Note 2)	I_S		-	-	5	A

.P..CH.Electrical Characteristics (T_A=25°C unless otherwise noted)

Parameter	Symbol	Condition	Min	Typ	Max	Unit
Off Characteristics						
Drain-Source Breakdown Voltage	BV _{DSS}	V _{GS} =0V, I _D =-250μA	-20	-22	-	V
Zero Gate Voltage Drain Current	I _{DSS}	V _{DS} =-24V, V _{GS} =0V	-	-	-1	μA
Gate-Body Leakage Current	I _{GSS}	V _{GS} =±20V, V _{DS} =0V	-	-	±100	nA
On Characteristics (Note 3)						
Gate Threshold Voltage	V _{GS(th)}	V _{DS} =V _{GS} , I _D =-250μA	-0.45	-0.7	-1	V
Drain-Source On-State Resistance	R _{DS(on)}	V _{GS} =-4.5V, I _D =-4.1A	-	39	52	mΩ
		V _{GS} =-2.5V, I _D =-4A	-	58	75	mΩ
Forward Transconductance	g _{FS}	V _{DS} =-5V, I _D =-4.1A	5.5	-	-	S
Dynamic Characteristics (Note4)						
Input Capacitance	C _{iss}	V _{DS} =-15V, V _{GS} =0V, F=1.0MHz	-	700	-	PF
Output Capacitance	C _{oss}		-	120	-	PF
Reverse Transfer Capacitance	C _{rss}		-	75	-	PF
Switching Characteristics (Note 4)						
Turn-on Delay Time	t _{d(on)}	V _{DD} =-15V, R _L =3.6Ω V _{GS} =-10V, R _{GEN} =3Ω	-	9	-	nS
Turn-on Rise Time	t _r		-	5	-	nS
Turn-Off Delay Time	t _{d(off)}		-	28	-	nS
Turn-Off Fall Time	t _f		-	13.5	-	nS
Total Gate Charge	Q _g	V _{DS} =-15V, I _D =-4A, V _{GS} =-10V	-	14	-	nC
Gate-Source Charge	Q _{gs}		-	3.1	-	nC
Gate-Drain Charge	Q _{gd}		-	3.	-	nC
Drain-Source Diode Characteristics						
Diode Forward Voltage (Note 3)	V _{SD}	V _{GS} =0V, I _S =-1A	-	-	-1.2	V

Notes:

1. Repetitive Rating: Pulse width limited by maximum junction temperature.
2. Surface Mounted on FR4 Board, t ≤ 10 sec.
3. Pulse Test: Pulse Width ≤ 300μs, Duty Cycle ≤ 2%.
4. Guaranteed by design, not subject to production

N- Channel Typical Electrical and Thermal Characteristics (Curves)

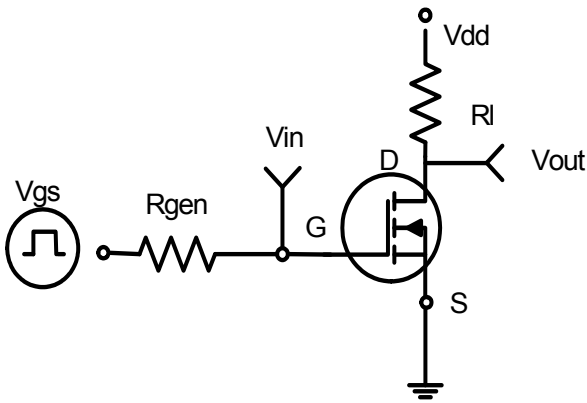

Figure 1: Switching Test Circuit

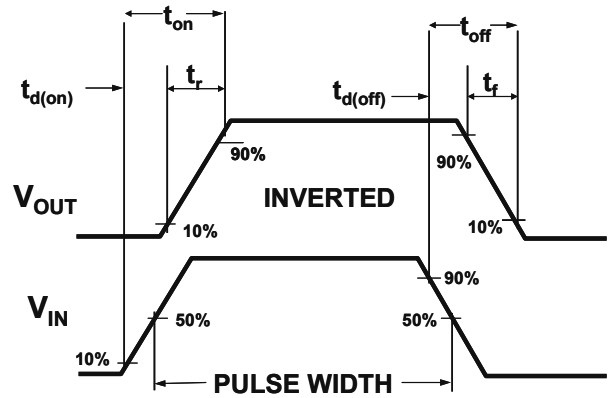

Figure 2: Switching Waveforms

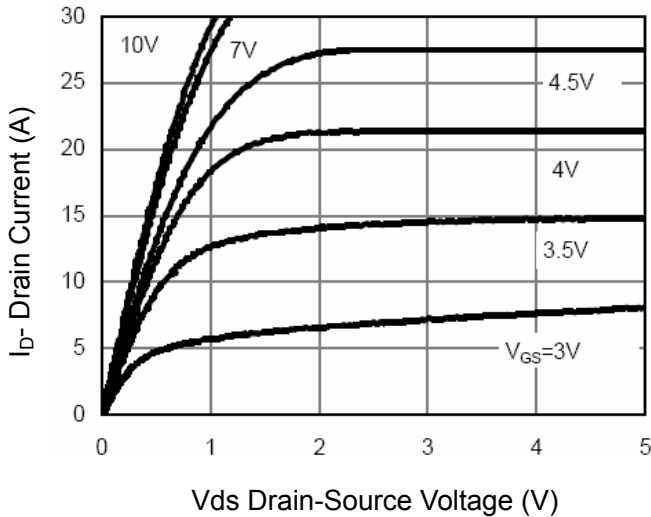

Figure 3 Output Characteristics

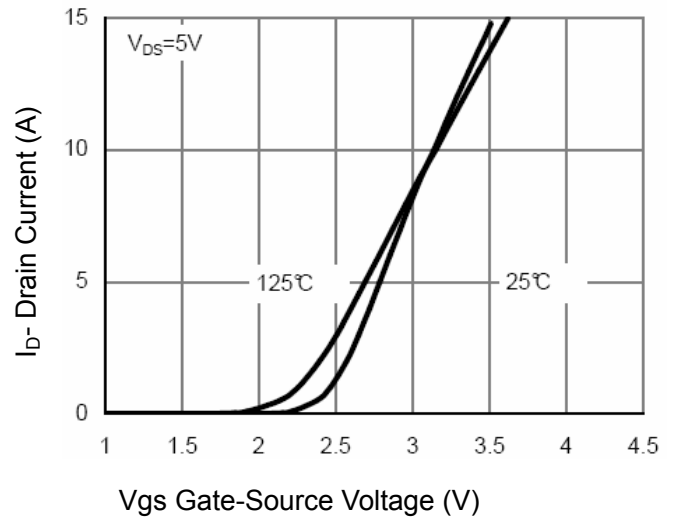

Figure 4 Transfer Characteristics

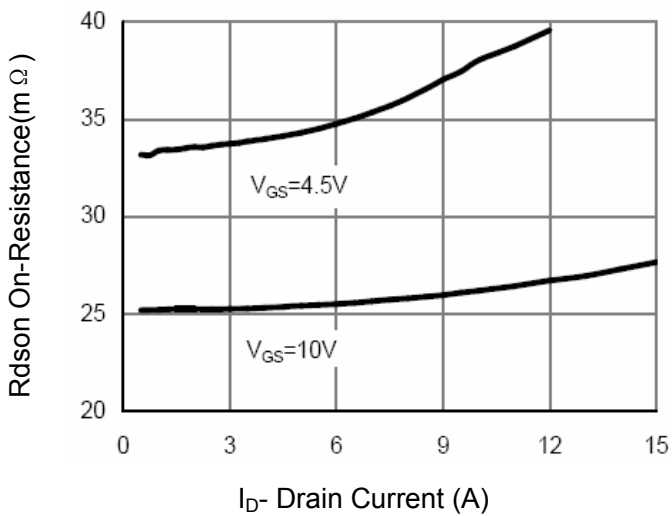

Figure 5 Drain-Source On-Resistance

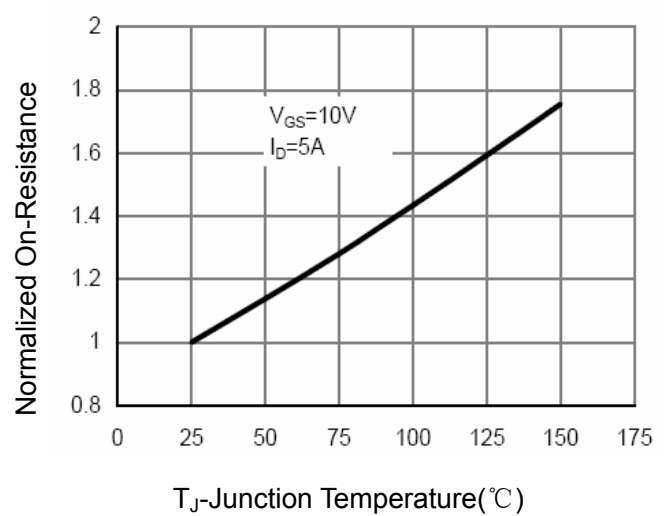
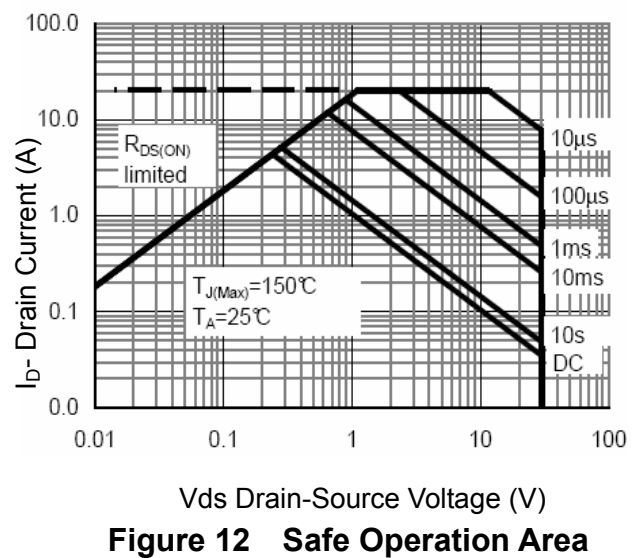
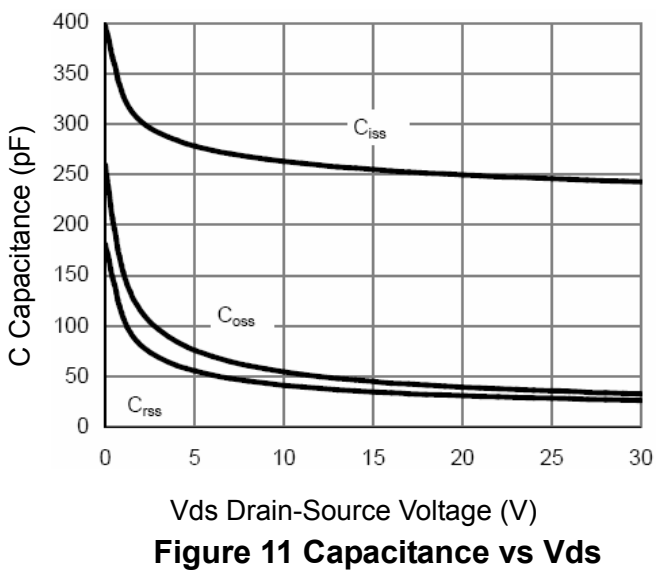
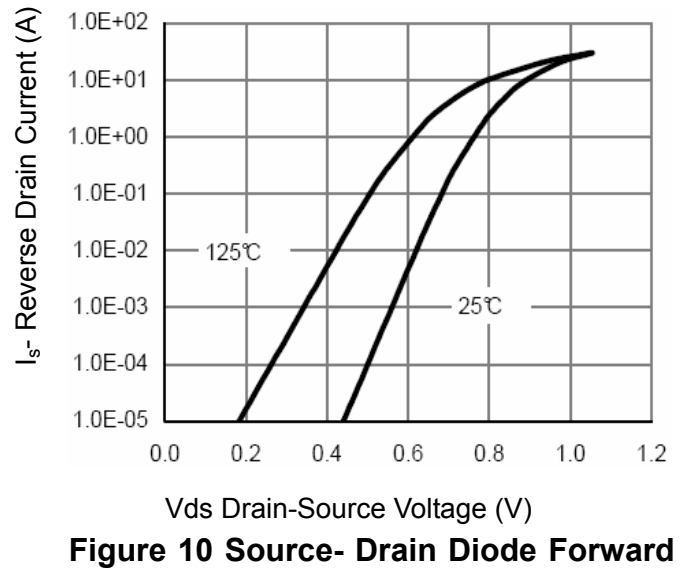
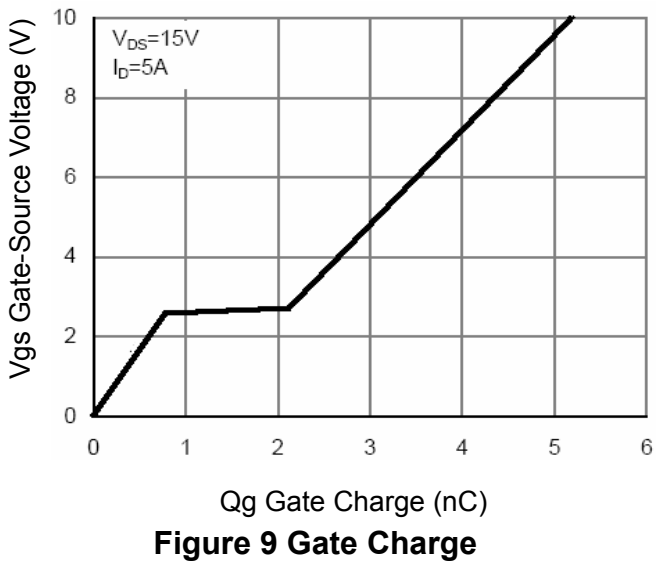
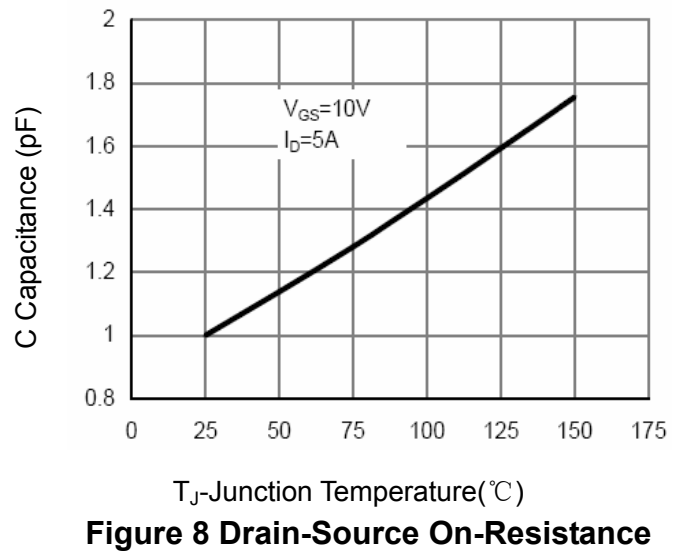
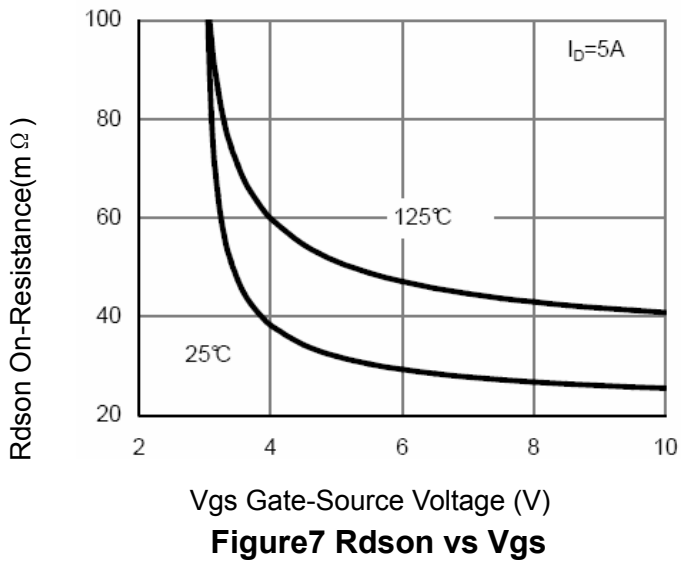

Figure 6 Drain-Source On-Resistance



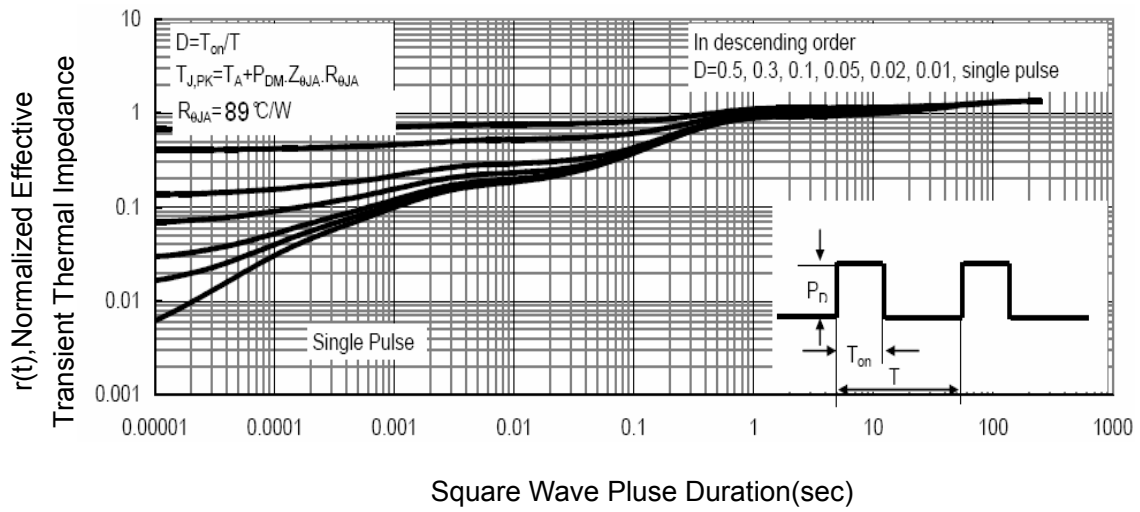

Figure 13 Normalized Maximum Transient Thermal Impedance

P-Channel Typical Electrical and Thermal Characteristics

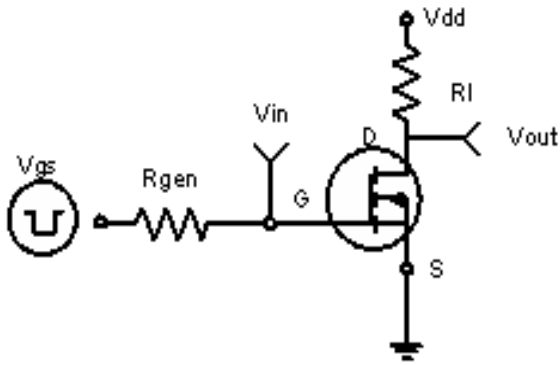

Figure 1: Switching Test Circuit

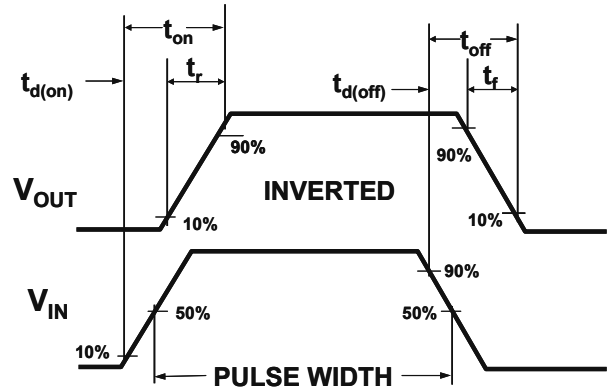

Figure 2: Switching Waveforms

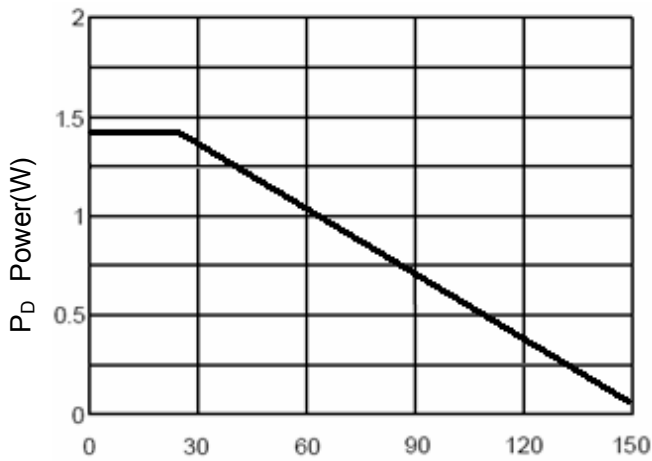

Figure 3 Power Dissipation

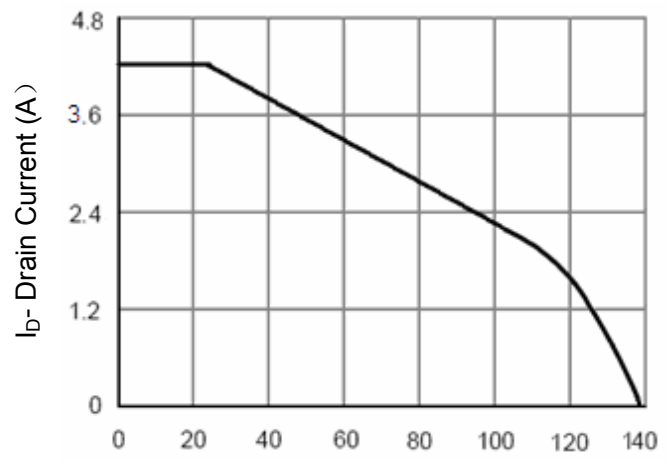

Figure 4 Drain Current

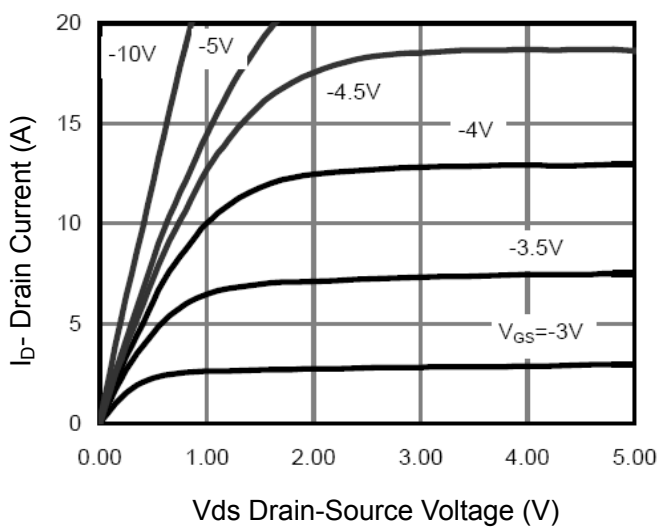

Figure 5 Output CHARACTERISTICS

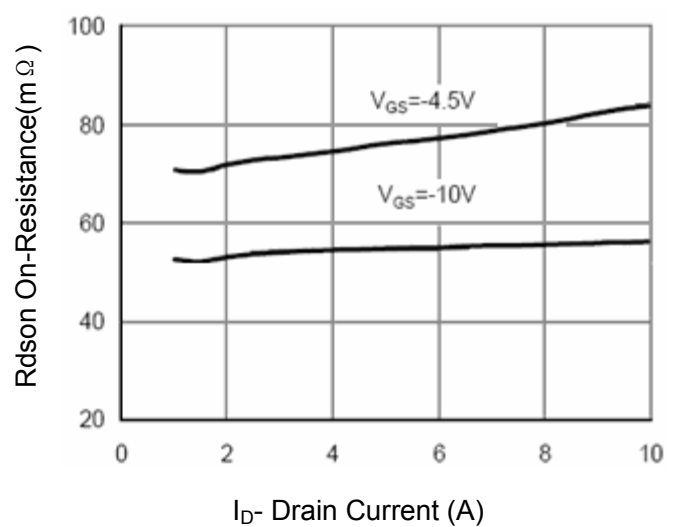

Figure 6 Drain-Source On-Resistance

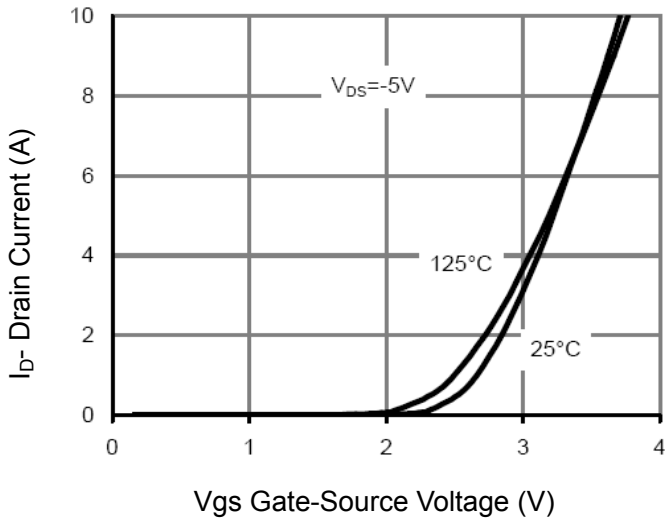

Figure 7 Transfer Characteristics

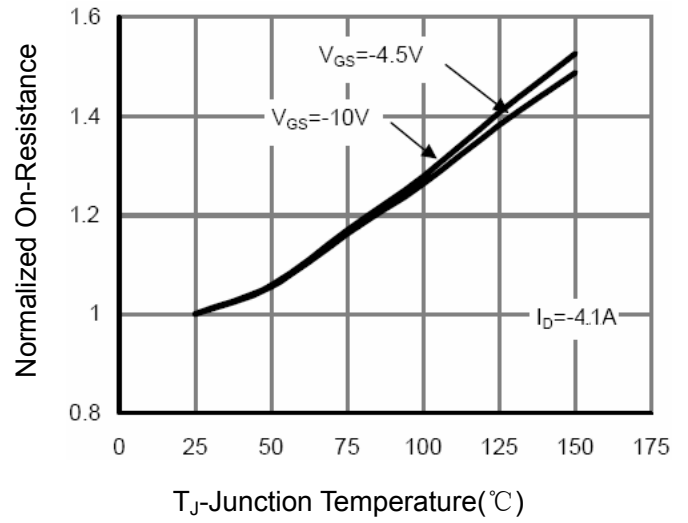

Figure 8 Drain-Source On-Resistance

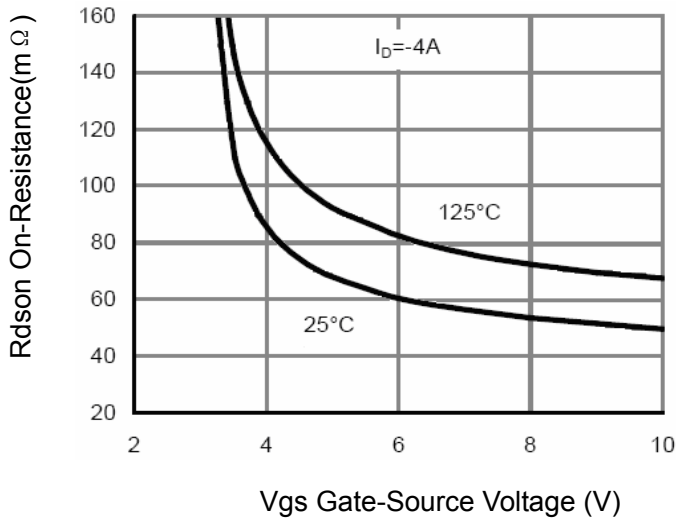

Figure 9 Rdson vs Vgs

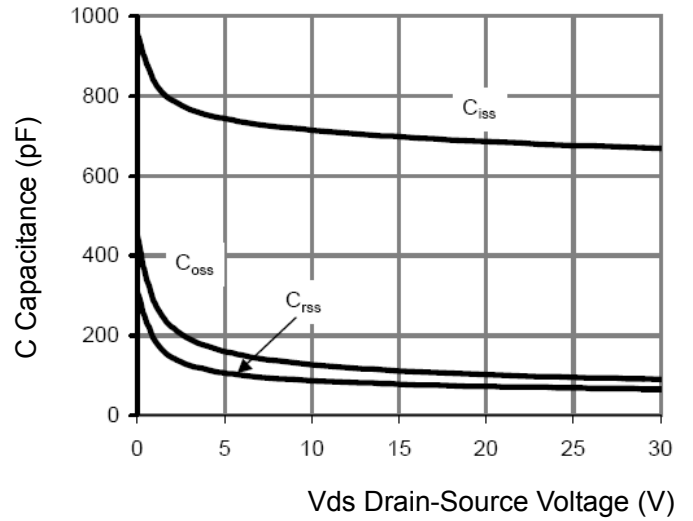

Figure 10 Capacitance vs Vds

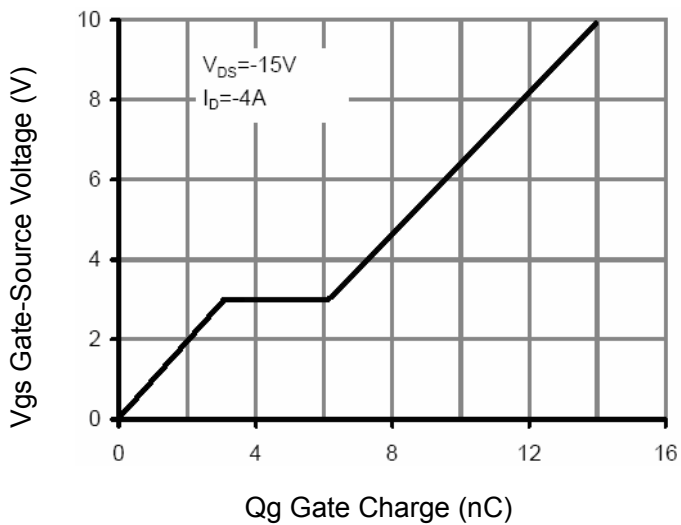

Figure 11 Gate Charge

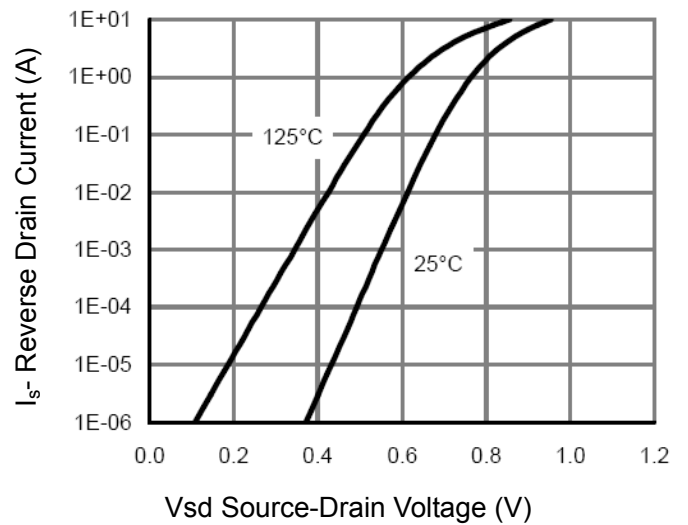

Figure 12 Source- Drain Diode Forward

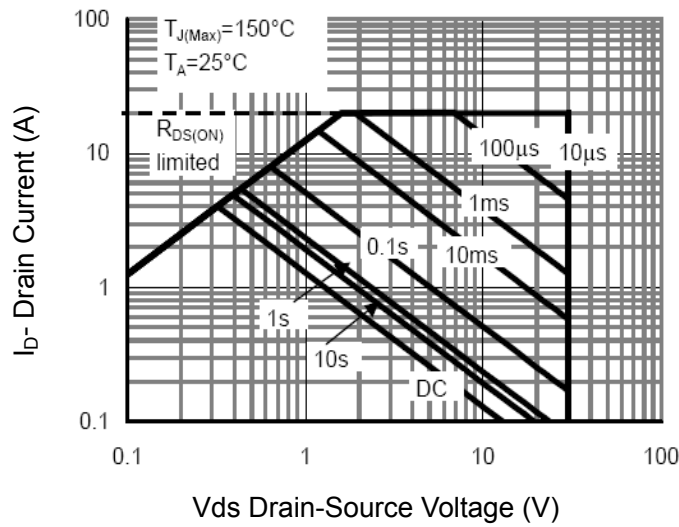

Figure 13 Safe Operation Area

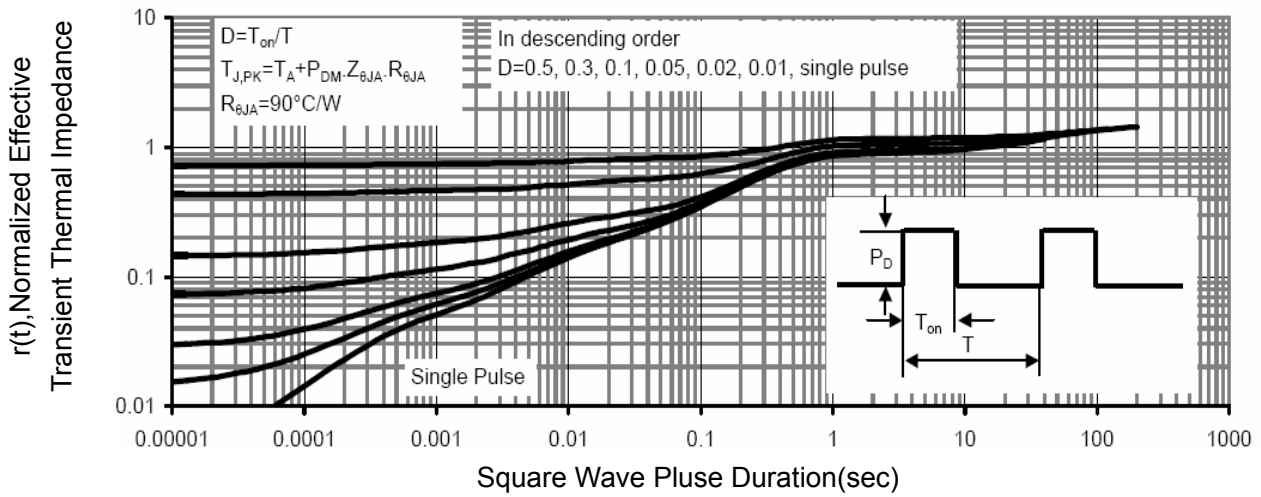
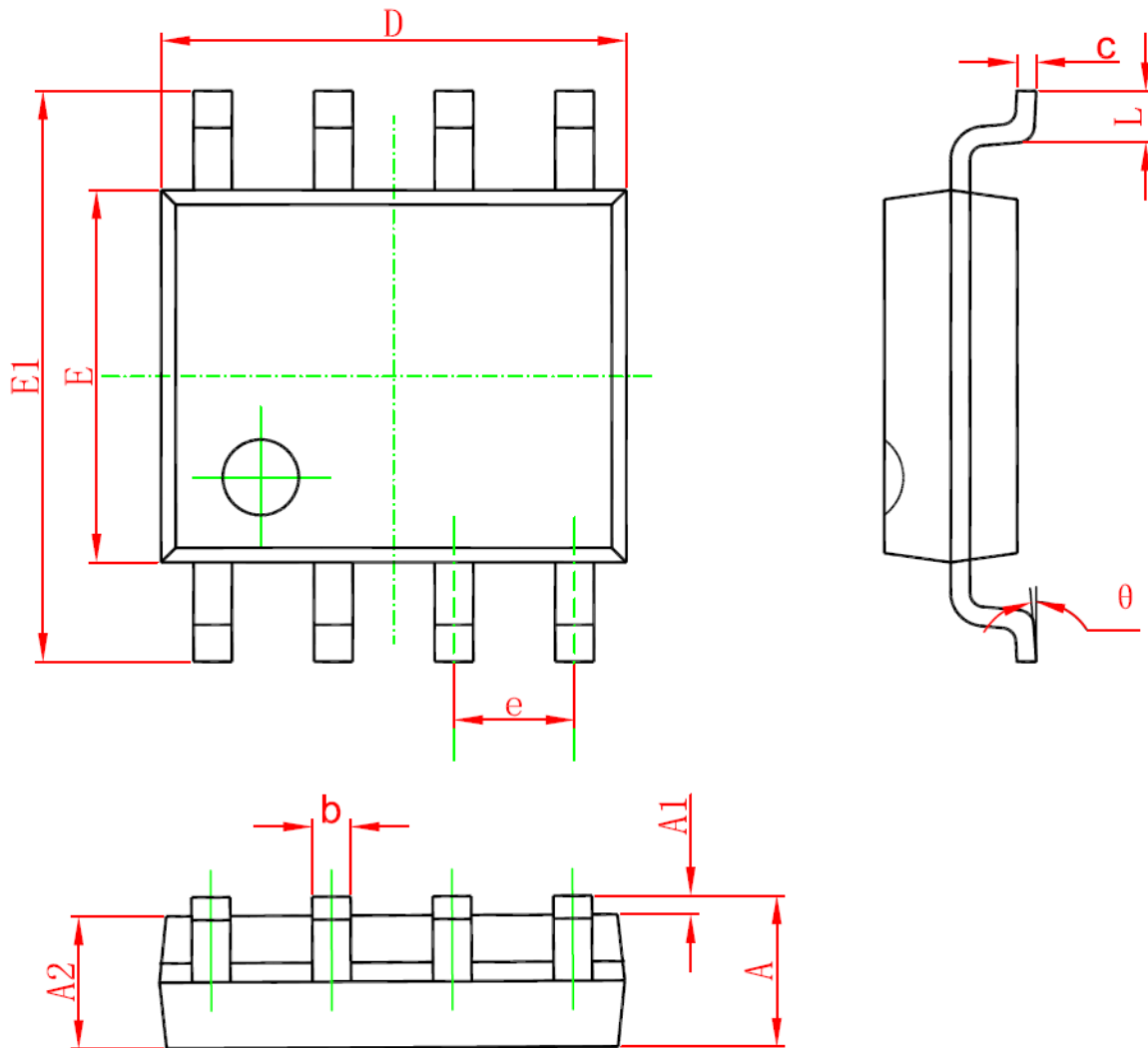

Figure 14 Normalized Maximum Transient Thermal Impedance

SOP-8 Package Information



Symbol	Dimensions In Millimeters		Dimensions In Inches	
	Min	Max	Min	Max
A	1.350	1.750	0.053	0.069
A1	0.100	0.250	0.004	0.010
A2	1.350	1.550	0.053	0.061
b	0.330	0.510	0.013	0.020
c	0.170	0.250	0.006	0.010
D	4.700	5.100	0.185	0.200
E	3.800	4.000	0.150	0.157
E1	5.800	6.200	0.228	0.244
e	1.270 (BSC)		0.050 (BSC)	
L	0.400	1.270	0.016	0.050
θ	0°	8°	0°	8°